



92x92x38mm A9C38T Series AC Axial Fan



Specification:

Air Flow	42~ 49 CFM
Housing	Die-Cast Aluminum, Painted Black
Impeller	Thermoplastic PBT, UL94V-0
Bearing	Ball or Sleeve
Termination	Terminals or Lead Wire
Operating Voltage Range	85VAC to 125VAC for 115V Type 185VAC to 245 VAC for 230V Type
Insulation	Class "B" or "F"
Safety	Impedance Protected
Operating Temperature	-10°C to + 70°C for Sleeve Type -20°C to + 80°C for Ball Type
Weight(g)	446g



Item Code	Bearing Availability	Rated Voltage	Frequency (Hz)	Rated Current(A)	Input Power(W)	Speed (RPM)	Air Flow (CFM)	Air Flow (m³/min)	Static Pressure (inch-H ₂ O)	Noise dB(A)
A1V9C38TBL-1	B,S	115V	50/60	0.19/0.15	14/11	2800/3200	42/49	1.20/1.40	0.20/0.28	40/45
A2V9C38TBL-1	B,S	230V	50/60	0.10/0.08	15/12	2800/3200	42/49	1.20/1.40	0.20/0.28	40/45

For "Sleeve" bearing version, change the "B" in the model number to "S".

For "Terminal" version, change the "L" in the model number to "T"

Outline Drawing: Unit:mm(Inch)

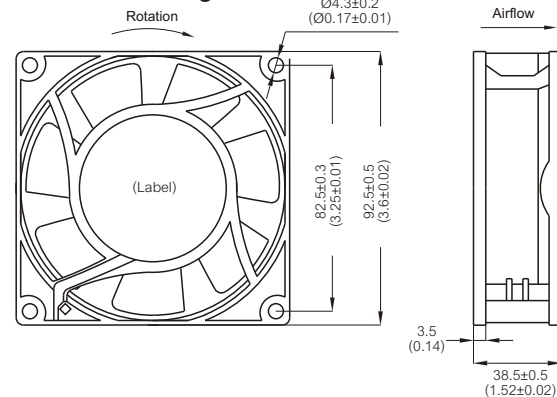

Characteristic Curves:

