



Ø225x85mm BA225-85T Series AC Centrifugal Fan



Specification:

Air Flow	586 ~ 669CFM
Impeller	Plastic PA (Polyamide Glass-fiber Reinforced)
Motor	Capacitor-Run Induction and External Rotor Motor
Rotor	Black Paint
Bearing	Dual Ball Bearing, Permanently Lubricated
Operating Voltage Range	85VAC to 125VAC for 115V Type 185VAC to 245 VAC for 230V Type
Lead Wire	AWG# 18 UL
Insulation	Class "B" or "F"
Safety	Thermally Protected (Auto Restart)
Operating Temperature	-20°C to +60°C
Weight	1960g



Item Code	Rated Voltage	Frequency (Hz)	Rated Current(A)	Input Power(W)	Speed (RPM)	Air Flow (CFM)	Air Flow (m³/min)	Static Pressure (inch-H ₂ O)	Noise dB(A)	Capacitor (µF)
BA1V225-85T-FPA-B7-2C	115V	50/60	1.08/1.20	112/136	2600/2950	586/669	16.6/19.0	1.99/2.71	68/71	12µF 200VAC
BA2V225-85T-FPA-B7-2C	230V	50/60	0.55/0.60	113/136	2600/2950	587/669	16.7/19.0	2.00/2.73	68/71	3µF 400VAC

Outline Drawing:

Unit:mm(Inch)

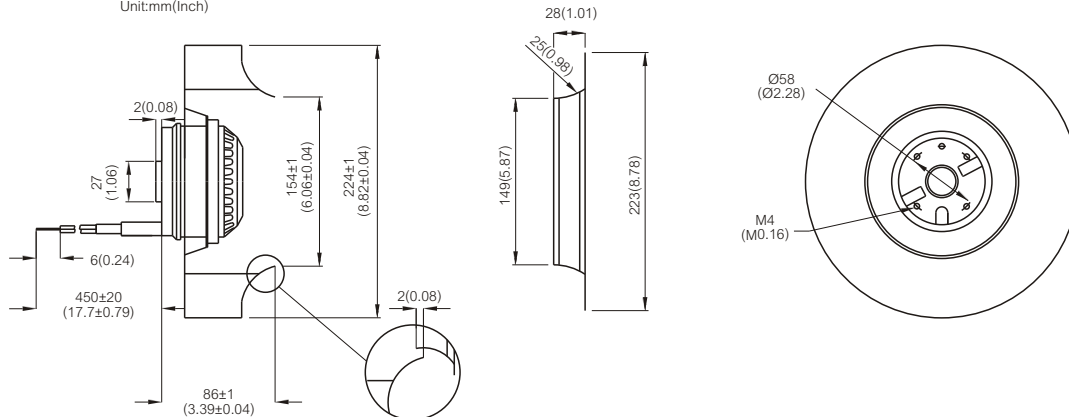

Characteristic Curves:

